



# Technical Data Sheet

## OPTO INTERRUPTER ITR

### ITR9907

#### ■ Features

- Fast response time
- High sensitivity
- Cut-off visible wavelength  $\lambda_p=940\text{nm}$
- Thin
- Small package
- Pb free
- The product itself will remain within RoHS compliant version.

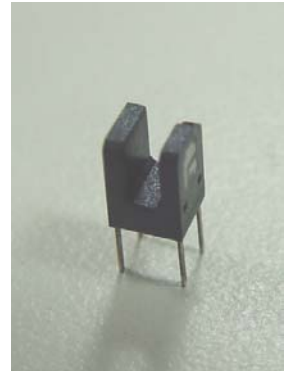

#### ■ Descriptions

The **ITR9907** consists of an infrared emitting Diode and a silicon phototransistor encased in a black Thermo-plastic housing. The advantage of the device is the small package. Phototransistor receives radiation from the IRED only, and avoids the noise from ambient light

#### ■ Applications

- Camera
- Copier
- Scanner
- Non-contact Switching
- For Direct PC Board

#### ■ Device Selection Guide

Device No.	Chip Material
IR	GaAs
PT	Silicon

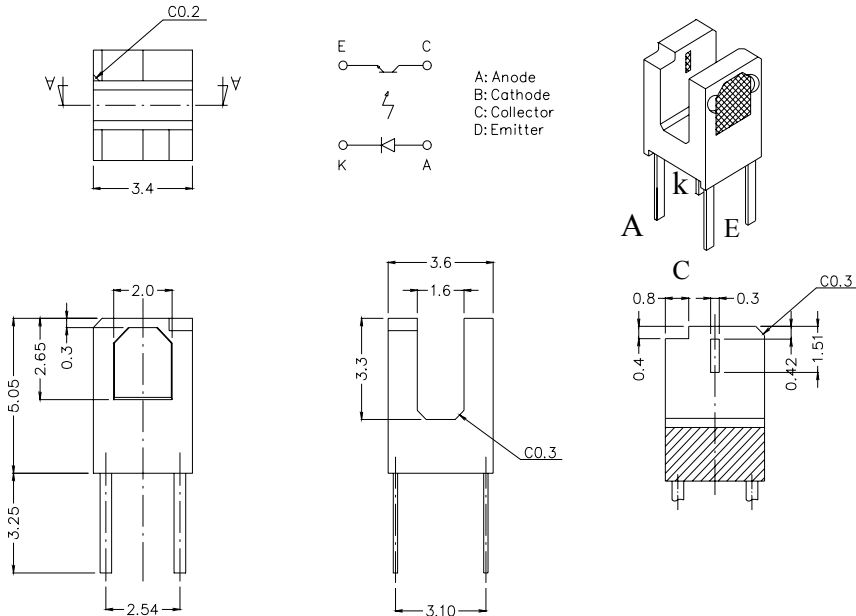
**Package Dimensions**

- Notes:** 1. All dimensions are in millimeters  
 2. Tolerances unless dimensions  $\pm 0.25\text{mm}$

**Absolute Maximum Ratings (Ta=25°C)**

Parameter		Symbol	Ratings	Unit
Input	Power Dissipation at (or below) 25°C Free Air Temperature	Pd	75	mW
	Reverse Voltage	V <sub>R</sub>	5	V
	Forward Current	I <sub>F</sub>	50	mA
	Peak Forward Current (*1) Pulse width $\leq 100 \mu\text{s}$ , Duty cycle=1%	I <sub>FP</sub>	1	A
Output	Collector Power Dissipation	P <sub>C</sub>	75	mW
	Collector Current	I <sub>C</sub>	20	mA
	Collector-Emitter Voltage	B V <sub>CEO</sub>	30	V
	Emitter-Collector Voltage	B V <sub>ECO</sub>	5	V
Operating Temperature		T <sub>opr</sub>	-25~+85	°C
Storage Temperature		T <sub>stg</sub>	-40~+85	°C
Lead Soldering Temperature (*2)		T <sub>sol</sub>	260	°C

(\*1)  $t_w=100 \mu\text{sec.}$ ,  $T=10 \text{msec.}$       (\*2)  $t=5 \text{Sec}$

**Electro-Optical Characteristics (Ta=25°C)**

Parameter		Symbol	Min.	Typ.	Max.	Unit	Conditions
Input	Forward Voltage	$V_F$	---	1.2	1.6	V	$I_F=20\text{mA}$
	Reverse Current	$I_R$	---	---	10	$\mu\text{A}$	$V_R=5\text{V}$
	Peak Wavelength	$\lambda_P$	---	940	---	nm	---
Output	Dark Current	$I_{CEO}$	---	---	100	nA	$V_{CE}=10\text{V}$
	C-E Saturation Voltage	$V_{CE}(\text{sat})$	---	---	0.4	V	$I_C=2\text{mA}$ $E_e=1\text{mW/cm}^2$
Transfer Characteristics	Collector Current	$I_C(\text{ON})$	50	---	---	$\mu\text{A}$	$V_{CE}=5\text{V}$ , $I_F=5\text{mA}$
	Leakage Current	$I_{CEOD}$	---	---	1	$\mu\text{A}$	$V_{CE}=5\text{V}$ $I_F=20\text{mA}$
	Rise time	$t_r$	---	15	---	$\mu\text{sec}$	$V_{CE}=2\text{V}$ $I_C=1\text{mA}$ $R_L=1\text{K}\Omega$
	Fall time	$t_f$	---	15	---	$\mu\text{sec}$	

**Typical Electrical/Optical/Characteristics Curves for IR**

Fig.1 Forward Current vs. Ambient Temperature

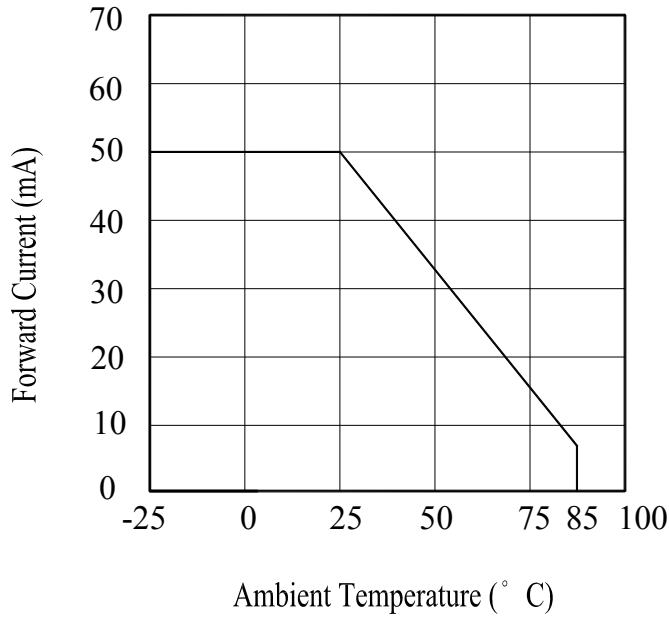

Fig.2 Spectral Distribution

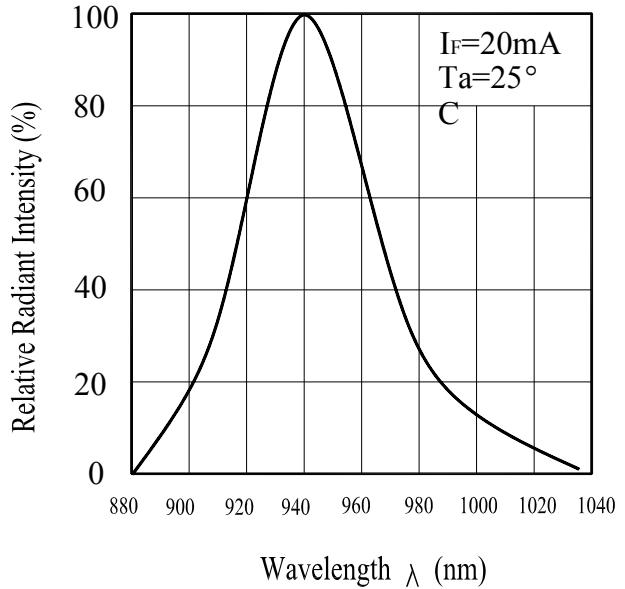

Fig.3 Peak Emission Wavelength vs. Ambient Temperature

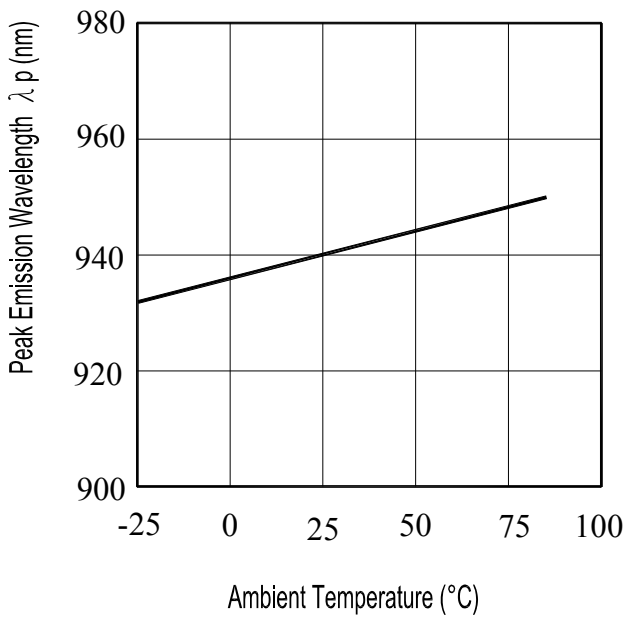

Fig.4 Forward Current vs. Forward Voltage

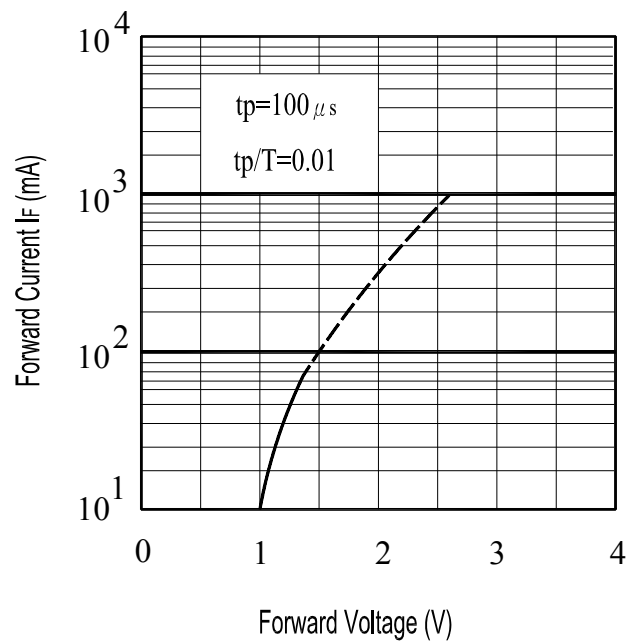

Fig.8 Forward Voltage vs. Ambient Temperature(°C)

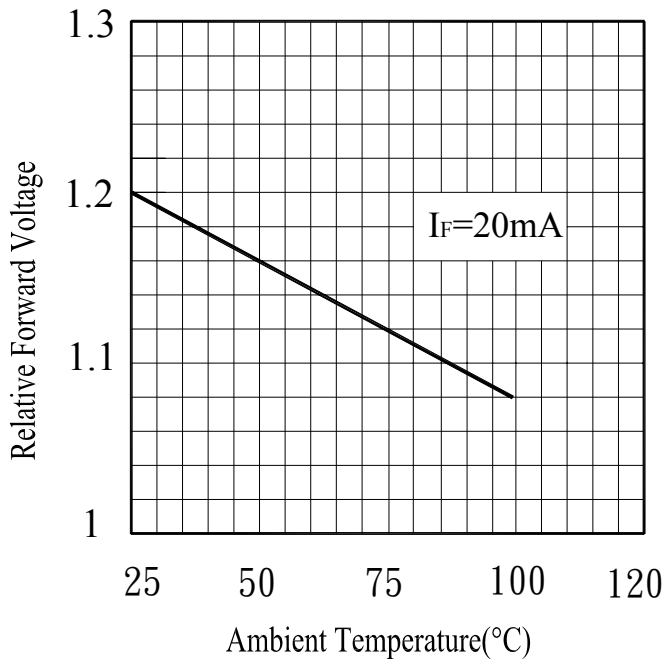
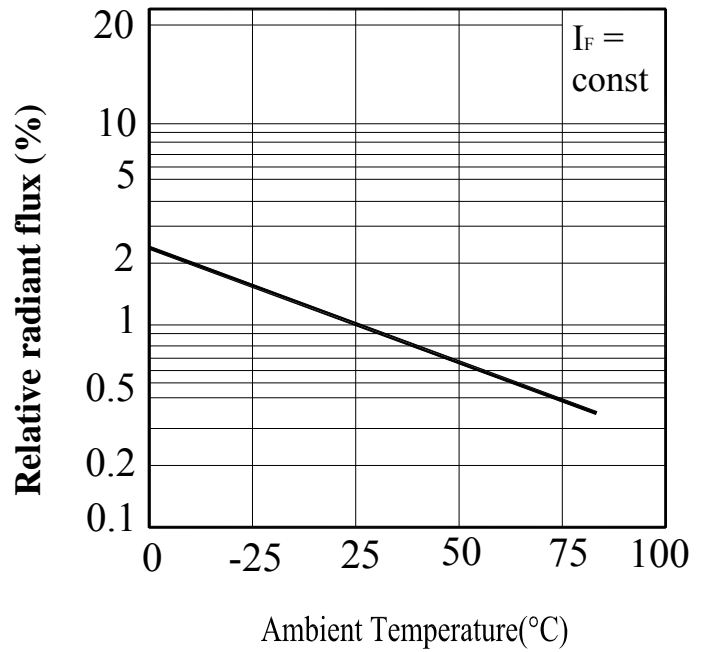

Fig.6 Relative Radiant Flux vs. Ambient Temperature(°C)



**Typical Electrical/Optical/Characteristics Curves for PT**

Fig.1 Collector Power Dissipation vs. Ambient Temperature

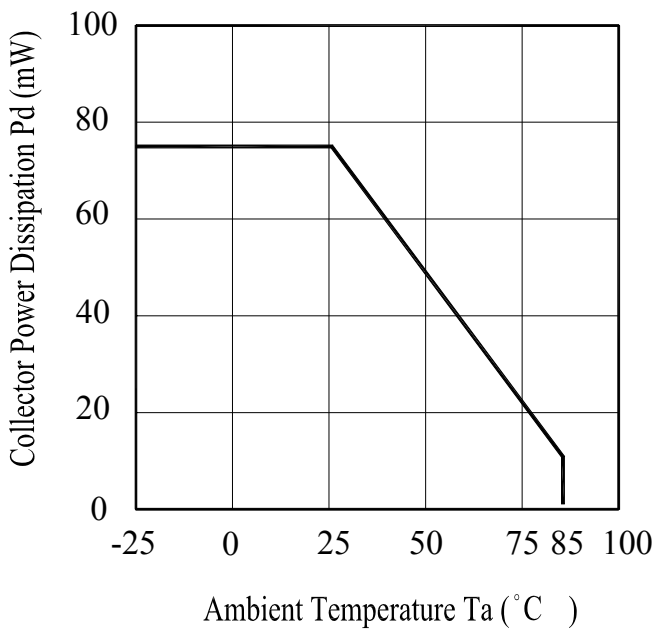

Fig.2 Spectral Sensitivity

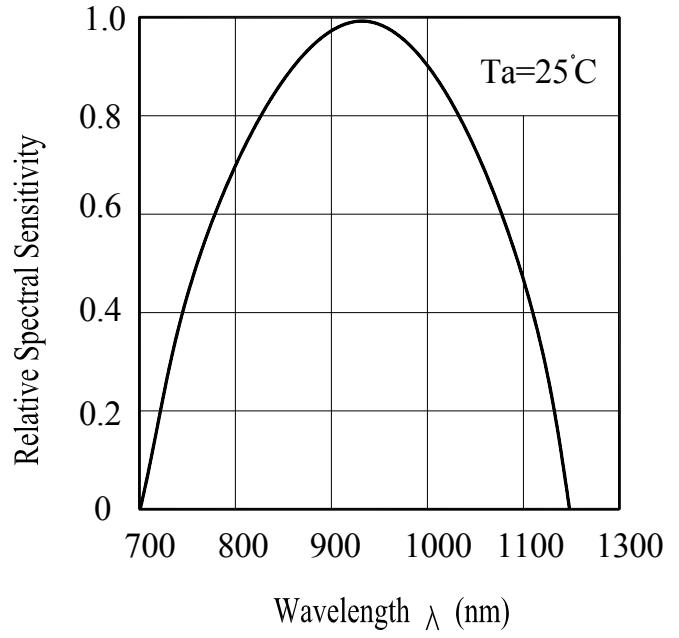

Fig.3 Relative Collector Current vs. Ambient Temperature

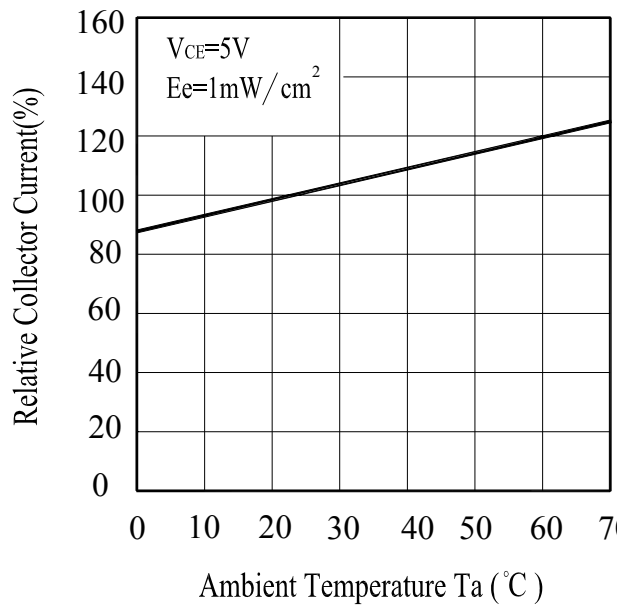
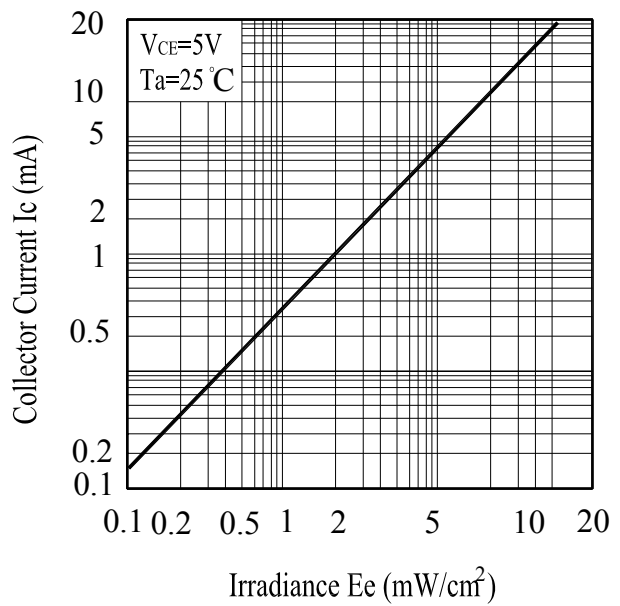

Fig.4 Collector Current vs. Irradiance



**Typical Electro-Optical Characteristics Curves**

Fig.5 Collector Dark Current vs. Ambient Temperature

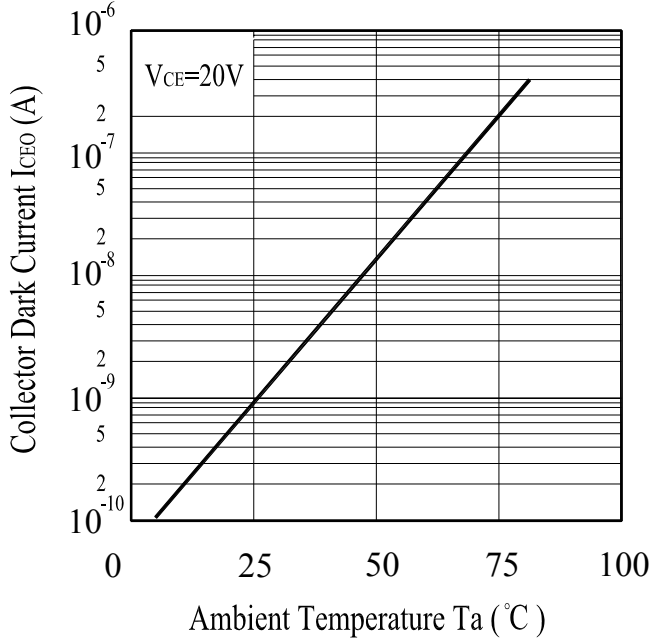
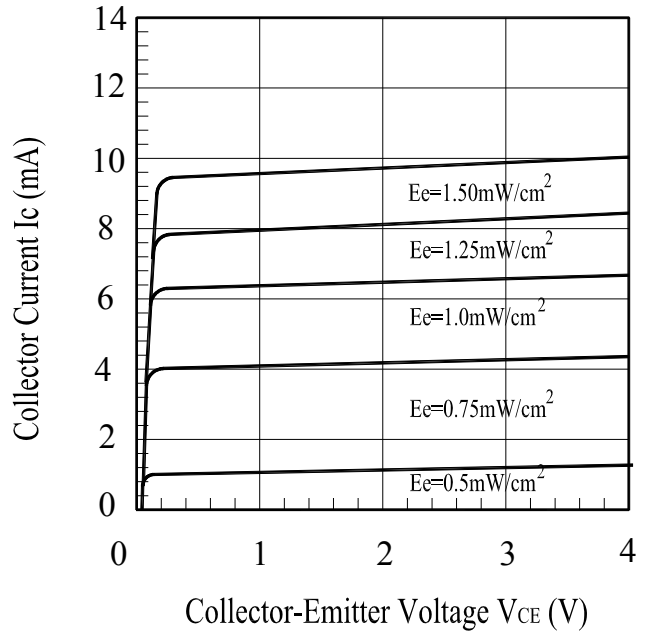

Fig.6 Collector Current vs. Collector-Emitter Voltage



**Reliability Test Item And Condition**

The reliability of products shall be satisfied with items listed below.

Confidence level : 90%

LTPD : 10%

NO.	Item	Test Conditions	Test Hours/ Cycles	Sample Sizes	Failure Judgement Criteria	Ac/Re
1	Solder Resistance	Ta = 260 ±3°C	10 ± 1 sec	22pcs		0/1
2	Temperature Cycle	H : +100°C    15mins ↕    5mins L : -40°C       15mins	50Cycles	22pcs	IR ≥ U×2 Ee ≤ L×0.8 VF ≥ U×1.2	0/1
3	Thermal Shock	H : +100°C    5mins ↕    10secs L : -10°C       5mins	50Cycles	22pcs	U : Upper Specification	0/1
4	High Temperature Storage	TEMP. : +100°C	1000hrs	22pcs	Limit L : Lower	0/1
5	Low Temperature Storage	TEMP. : -40°C	1000hrs	22pcs	Specification Limit	0/1
6	DC Operating Life	VCE=5V	1000hrs	22pcs		0/1
7	High Temperature/ High Humidity	85°C / 85% R.H	1000hrs	22pcs		0/1



